

ML SERIES

ML Series 95° Mini Soft Closing Concealed Hinge for Glass Doors with Fixed Plate



Specification

Opening Angle	95°
Function	Soft Close
Plate Type	Fixed Plate
Cup Depth	12.5 mm
Cup Diameter	26 mm
Drilling Distance	3 mm - 5 mm
Door Thickness	4 mm - 6 mm
Material	Cold Rolled Steel
Height Adjustment Range	4 mm
Overlay Adjustment Range	6 mm
Depth Adjustment Range	5 mm
Finish	Copper Nickel
Packaging	100 Units per Carton

Notable Features

- Compact design.

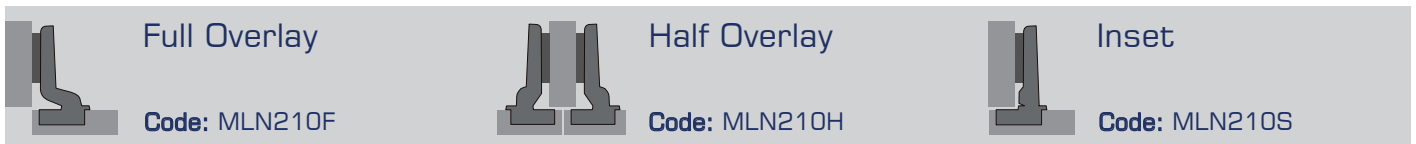

Additional Options: 1P - Individual Hinge, Caps for Arm and Cup, Mounting Plate and Screws in Sealed Bag
2P - Pair of Hinges, Caps for Arm and Cup, Mounting Plates and Screws in Sealed Bag
ND - No Damper

Drilling For Cup

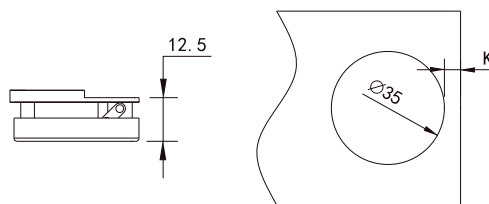

Cup Installation

Screw-on

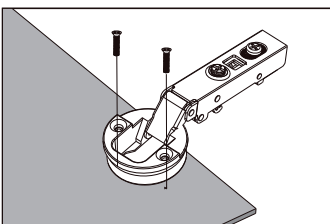

Installation Method	Code
Wood Screws	S2
Euro Screws	S4

Overlay Table

Full Overlay

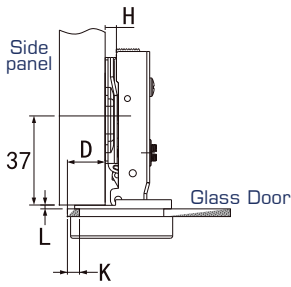

$$H = 11 + K - D$$

D \ K	3	4	5	6
H	0	14	15	16
2	12	13	14	15
4	10	11	12	13

Half Overlay

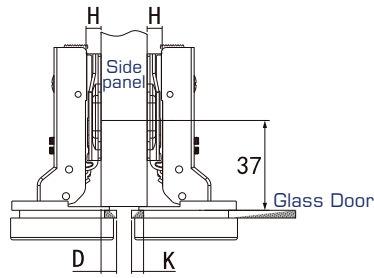

$$H = 2 + K - D$$

D \ K	3	4	5	6
H	0	5	6	7
2	3	4	5	6
4	1	2	3	4

Inset

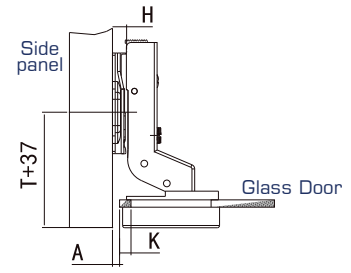

$$H = -4 + K + A$$

A \ K	3	4	5	6
H	0	1	0	-1
2	3	2	1	0
4	5	4	3	2

Minimum Reveal Table

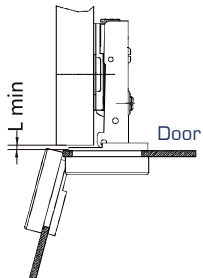
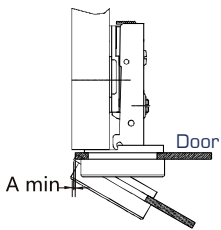

A \ T	K	12	13	14	15	16	17	18
3	0.0	0.0	0.1	0.6	1.2	1.7	2.2	
4	0.0	0.0	0.0	0.5	1.0	1.5	2.1	
5	0.0	0.0	0.0	0.3	0.9	1.4	1.9	
6	0.0	0.0	0.0	0.2	0.7	1.2	1.8	

L \ T	K	12	13	14	15	16	17	18
3	1.0	1.0	1.0	1.0	1.0	1.0	1.0	
4	1.0	1.0	1.0	1.0	1.0	1.0	1.0	
5	1.0	1.0	1.0	1.0	1.0	1.0	1.0	
6	1.0	1.1	1.2	1.3	1.4	1.5	1.6	

K = Boring distance

T = Door thickness

A = Minimum gap (A) for door with a door edge radius

L = Gap between door and panel

Note:

The minimum parameters in the reveal tables are based on doors with straight, square edges. A rounded or beveled profile will change the minimum reveal required.

Hinge Adjustment

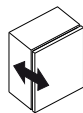
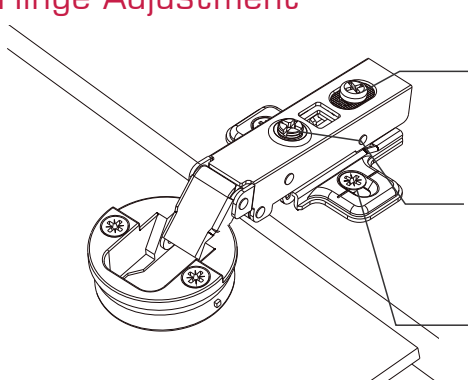

Depth Adjustment

Rotate the hinge arm cam to increase or decrease door gap.

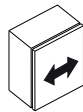

Horizontal Adjustment

Rotate the hinge arm screw to increase or decrease door overlay.

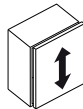

Vertical Adjustment

Adjust the mounting plate to increase or decrease the door height.

Note:

The referenced adjustment range described is the product design range. The actual design of the cabinet and the drilling method may have a certain impact on the parameters.